



BT 28106
28 USt Lifting Capacity
Boom Truck Cranes
Datasheet
Imperial

BT 28106



Features

- ▶ 28 USt @ 6 ft capacity at rated distance from center of rotation
- ▶ 106 ft maximum boom length
- ▶ 115 ft maximum tip height
- ▶ 30/47 ft optional jib, offsettable 0°, 15°, 30°
- ▶ 162 ft maximum sheave height with 47 ft jib
- ▶ Behind cab mounting with dual operator console
- ▶ Electronic rated capacity indicator with work area definition
- ▶ Quick reeving boom head
- ▶ K-pattern outriggers

WORKS FOR YOU.™

Key

..... 3

Dimensions





Crane Dimensions 4, 5
Area of Operations 5
Mounting Specification 5
Range Diagram 6

Load charts

Boom Load Chart 7
Jib, Retracted 8
Jib, Extended 8

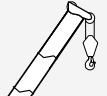
Technical description

Boom, Jib and Rotation 9
Operator Controls, Operator Aids 9, 10
Outriggers 10
Optional Features 10

	Main boom		Main Hoist
	Boom length		Hoist line speed
	Tip height		Part line
	Telescoping mode		Operator aid
	Boom angle		Controls
	Working radius		Hydraulics
	Boom with jib		Working temperature
	Boom head		Outriggers
	Hook block		Rotation / Allowable rotation range
	Hook to head sheave pin		Working speeds
	Rope – Standard / Optional		Boom over the rear
	Rope diameter		Boom over the front
	Rope length		Area of operation
	Line pull		

DIMENSIONS

BT 28106

Crane Dimensions

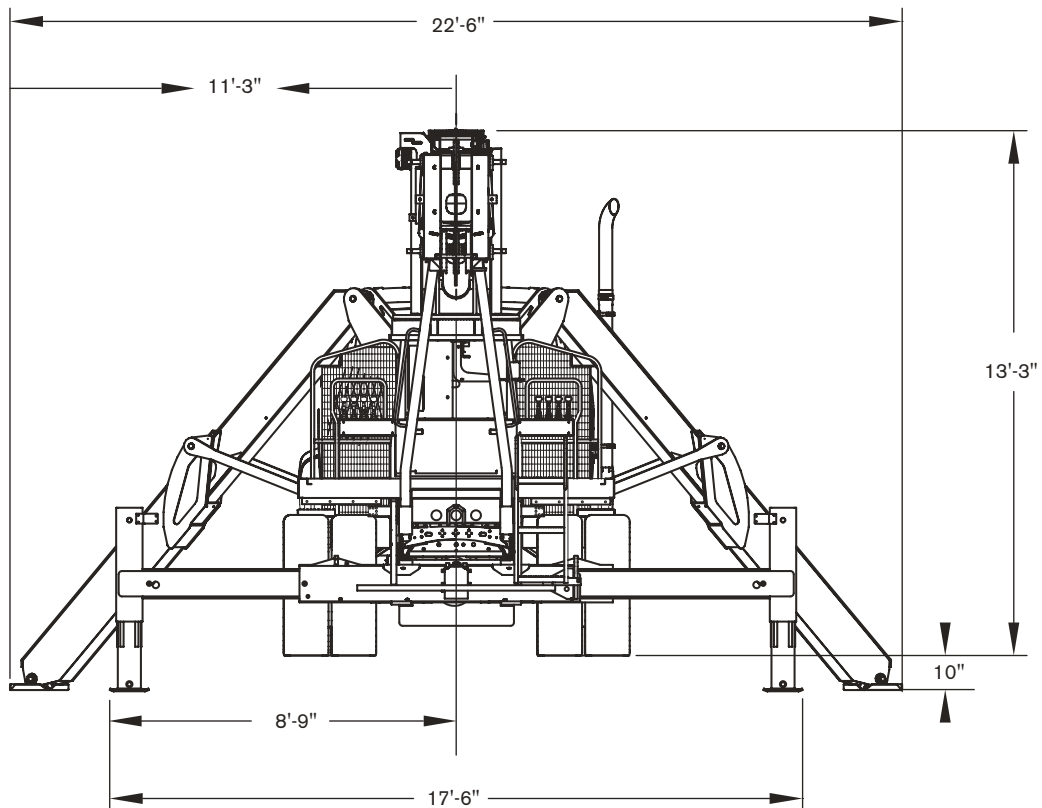
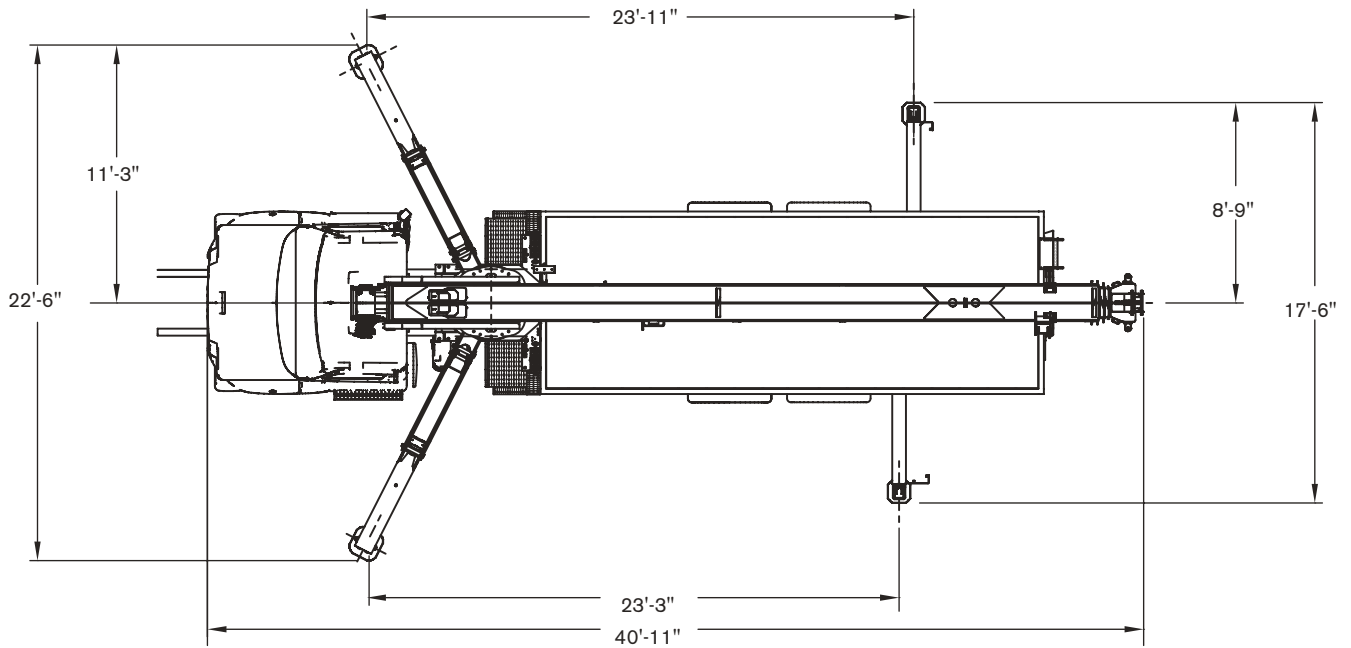

DIMENSIONS

BT 28106

Crane Dimensions

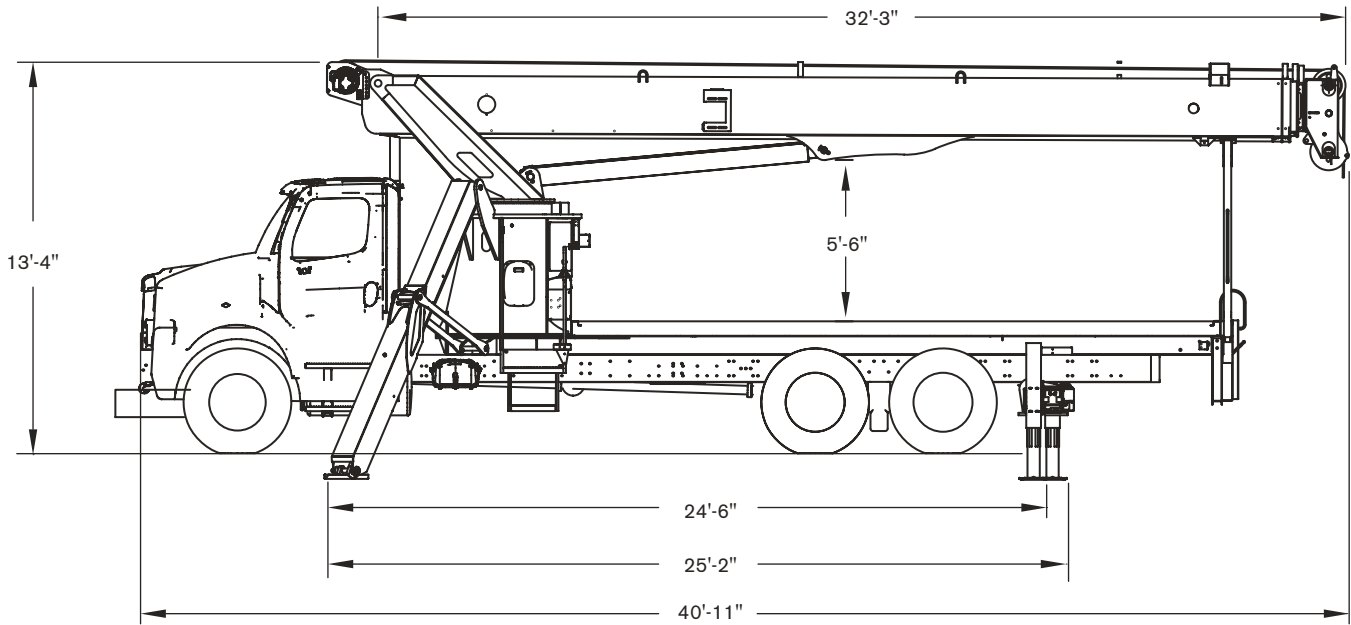

Area of Operation

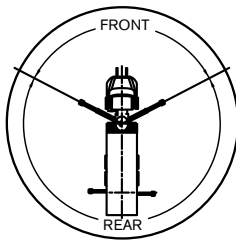

Mounting Specifications

Gross Vehicle Weight Rating	52,000 lb
Front Axle Weight Rating	18,000 lb
Rear Axle Weight Rating	34,000 lb
Wheelbase	260 in
Cab to Axle	192 in
Afterframe	114 in
RBM per Frame Rail (min)	3,300,000 lb/in
Frame Height (Unloaded)	40 in
Vertical Exhaust Height	110 in

Estimated installed crane weight 30,000 lbs
 Crane fitted with jib and mounted on freightliner chassis with flatbed.

Approximate weight distribution:

Front axle	15,400 lbs
Tandem axles	31,000 lbs
Total weight	46,400 lbs

Estimated freightliner bare chassis weight:

Front axle	9,140 lbs*
Tandem axles	8,270 lbs*
Total weight	17,410 lbs

* Minimum bare chassis weight requirements. Must ballast to minimum if required.

RANGE DIAGRAM

BT 28106

Outriggers Fully Extended (100%)

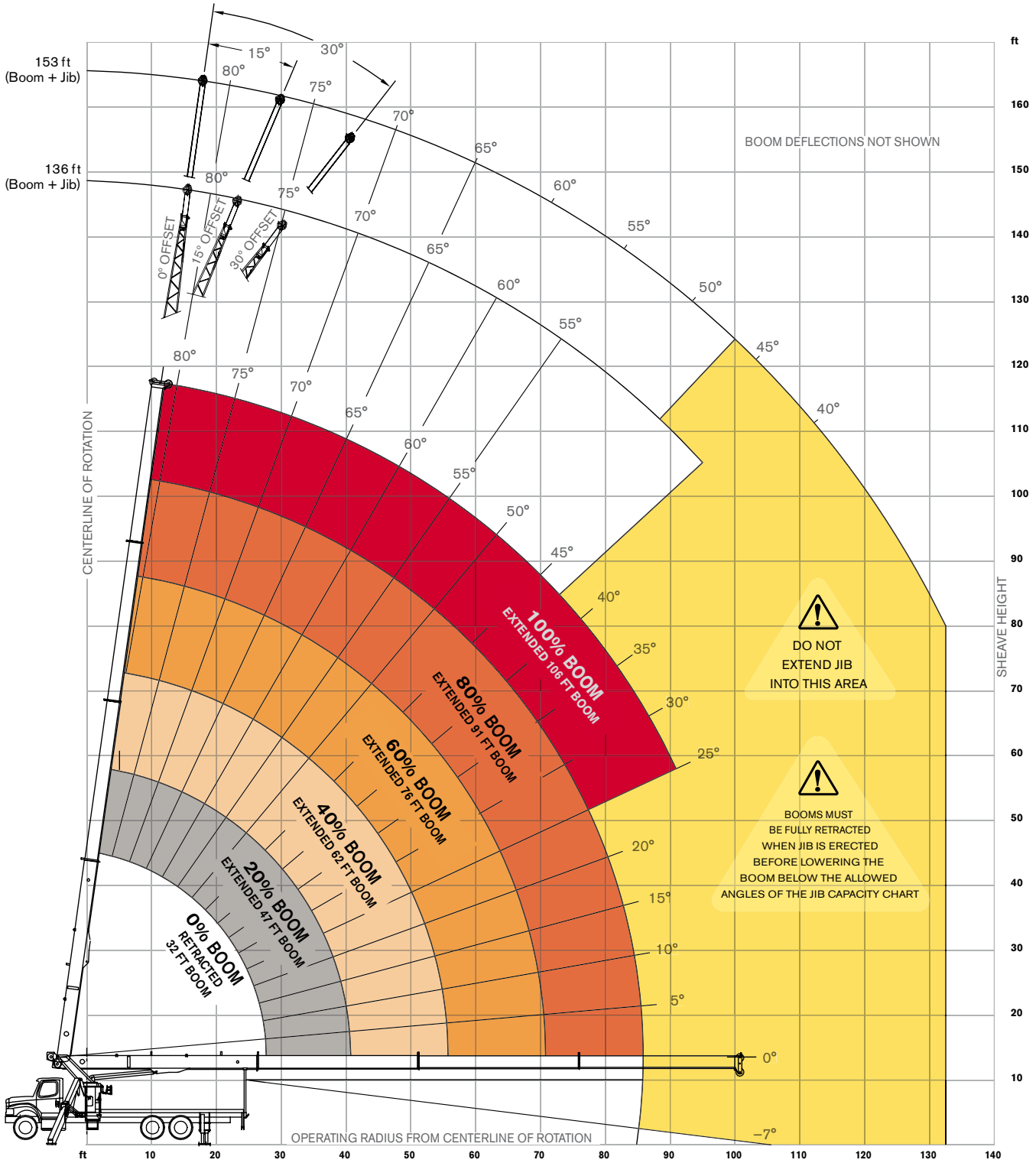
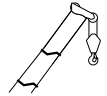

BOOM LOAD CHART

BT 28106

Outriggers Fully Extended (100%)

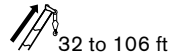

Standard ASME B30.5

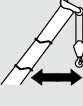
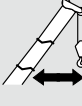
	Boom Length												
	32		47		62		76		91		106		
	ft	lb	lb	lb	lb	lb	lb	lb	lb	lb	lb	lb	
6	56,000	56,000											6
8	40,000	40,000	29,000	29,000									8
10	34,000	34,000	27,000	27,000	25,400	25,400							10
12	30,000	30,000	24,950	24,950	24,000	24,000							12
14	24,700	24,700	22,850	22,850	22,000	22,000	19,000	19,000	16,000	16,000			14
17	22,000	21,700	20,450	20,450	20,000	20,000	17,000	17,000	14,600	14,600			17
20	18,000	17,500	16,950	16,250	16,000	15,300	14,500	14,500	13,000	13,000	10,000	10,000	20
25	14,000	10,850	12,900	11,600	13,000	11,500	12,000	12,000	11,000	11,000	9,500	9,500	25
30			10,000	8,300	10,000	8,650	9,500	9,500	8,750	8,750	9,000	8,500	30
35			7,750	5,900	8,000	6,300	8,000	6,700	7,500	6,700	8,500	6,700	35
40			6,300	4,200	6,650	4,650	6,750	4,900	6,500	5,000	7,100	5,100	40
45					5,300	3,650	5,500	3,850	5,500	4,050	5,800	4,050	45
50					4,250	2,700	4,500	2,950	4,400	3,100	4,850	2,950	50
55					3,450	1,900	3,650	2,200	3,800	2,250	3,950	2,300	55
60							3,000	1,600	3,150	1,650	3,300	1,700	60
65							2,400	1,050	2,600	1,150	2,700	1,200	65
70							1,900	500	2,050	700	2,200	800	70
75									1,650	400	1,800	500	75
80									1,250		1,350		80
85									800		1,000		85
90											650		90
95											350		95

Notes to lifting capacity

Lifting capacities do not exceed 85% of tipping load. Weight of hook blocks and slings is part of the load, and is to be deducted from the capacity ratings. Consult operation manual for further details.

Note: Data published herein is intended as a guide only and shall not be construed to warrant applicability for lifting purposes. Crane operation is subject to the computer charts and operation manual both supplied with the crane.

LOAD CHART

BT 28106

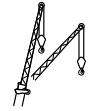

With Jib, Retracted



Standard ASME B30.5

ft	Jib 30 ft									ft
	0°			15°			30°			
	°	lb	lb	°	lb	lb	°	lb	lb	
30	80	5,000	5,000							30
35	78	5,000	5,000							35
40	75	5,000	5,000	81	4,800	4,000	82	4,000	4,000	40
45	72	4,800	4,250	79	4,800	4,000	79	4,000	4,000	45
50	70	4,500	3,250	74	4,200	3,850	77	4,000	4,000	50
55	68	3,800	2,550	72	3,700	3,050	75	3,600	3,350	55
60	65	3,100	1,900	70	3,300	2,300	72	3,200	2,700	60
65	63	2,450	1,300	67	2,650	1,700	70	2,800	2,100	65
70	60	1,800	800	65	2,000	1,100	67	2,350	1,500	70
75	58	1,350	450	62	1,600	750	64	1,900	1,100	75
80	55	900		59	1,200	400	60	1,500	700	80
85	51	575		56	800		57	1,150	425	85
90				52	400		54	800		90
95							51	550		95
100										100

With Jib, Extended



Standard ASME B30.5

ft	Jib 47 ft									ft
	0°			15°			30°			
	°	lb	lb	°	lb	lb	°	lb	lb	
30	82	4,000	4,000							30
35	80	4,000	4,000							35
40	78	4,000	4,000							40
45	76	3,550	3,300							45
50	74	3,330	2,500	79	3,300	3,300				50
55	72	2,900	2,000	77	3,200	3,200				55
60	70	2,300	1,500	75	3,100	3,100	78	2,500	2,500	60
65	67	1,850	1,100	73	2,950	2,550	76	2,500	2,500	65
70	65	1,400	700	70	2,800	2,000	74	2,400	2,400	70
75	63	1,050		68	2,350	1,550	71	2,250	1,950	75
80	61	750		65	1,900	1,150	69	2,100	1,500	80
85	59	500		63	1,450	725	66	1,700	1,100	85
90				61	1,000		63	1,300	700	90
95				57	750		61	1,000		95
100				55	500		58	700		100

Notes to lifting capacity

Lifting capacities do not exceed 85% of tipping load. Weight of hook blocks and slings is part of the load, and is to be deducted from the capacity ratings. Consult operation manual for further details.









Note: Data published herein is intended as a guide only and shall not be construed to warrant applicability for lifting purposes. Crane operation is subject to the computer charts and operation manual both supplied with the crane.









TECHNICAL DESCRIPTION

BT 28106

Boom, Jib and Rotation

	Four-section full power fully synchronized telescopic keel boom	
	Boom length	32–106 ft
	Boom maximum tip height	115 ft
	Boom elevation angle range (min/max)	-7° / 82°
	Boom up/down time Boom extension/retraction time	50/120 seconds 110/140 seconds
	Boom head Top shaft: 1 sheave / lower shaft: 3 sheave	3 Sheave quick reeving
	Tip height: Optional lattice jib 30/47 ft Angular offsets	162 ft 0°, 15°, 30°
	320° total swing- noncontinuous	

Operator Controls, Operator Aids

	Hydraulic 2-speed hoist	
	Hoist maximum line pulls Low High	11,854 lb 5,532 lb
	Hoist 3rd layer line speeds Low High	137 ft/min 209 ft/min
	Rope diameter	9/16"
	Breaking strength Permissible line pull (standard rope)	37,000 lb 10,500 lb
	Rope length	350 ft
	Overhaul ball 1 Sheave block 2 Sheave block 3 Sheave block	7 USt 15 USt 25 USt 30 USt

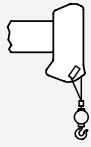

1 part line
 2 part line
 3 part line
 4 part line
 5 part line
 6 part line
 7 part line, optional rotational resistant rope only

9,600 lb / 172 ft/min
 19,200 lb / 86 ft/min
 28,800 lb / 57 ft/min
 38,400 lb / 43 ft/min
 48,000 lb / 34 ft/min
 51,800 lb / 29 ft/min
 57,000 lb / 24 ft/min

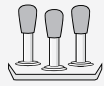

Proportional hydraulics
 Independent outrigger controls
 Bump throttle

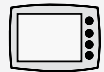

Rated capacity indicator with work area definition
 ATB system – internal wire

Outriggers



K-pattern

Front: Splayed A-link,
 To outer edge of pad

22 ft 6 in

Rear, "H" pattern (out and down),
 To outer edge of pad

17 ft 6 in

Optional Features

360° swing continuous rotation
 Two-stage jibs with offset capability 0°, 15°, 30°
 Rotation resistant rope
 Multi-part load blocks
 Main hoist with 2 speed motor
 Heavy duty wood flatbeds
 Extra heavy duty wood flatbeds
 Extra heavy duty steel flatbeds
 Radio remote controls
 One-man or two-man baskets
 Hoist drum tensioner
 Oil cooler
 Single front bumper outrigger
 Hydraulic hose reel
 Tool box
 Foot throttle
 Inching control for hoist operation at rear of subframe, for one man hook ball stowage and deploy

Lined area for notes, consisting of 20 horizontal lines on a light gray background.

Effective Date: July 2012. Product specifications and prices are subject to change without notice or obligation. The photographs and/or drawings in this document are for illustrative purposes only. Refer to the appropriate Operator's Manual for instructions on the proper use of this equipment. Failure to follow the appropriate Operator's Manual when using our equipment or to otherwise act irresponsibly may result in serious injury or death. The only warranty applicable to our equipment is the standard written warranty applicable to the particular product and sale and Terex makes no other warranty, express or implied. Products and services listed may be trademarks, service marks or trade-names of Terex Corporation and/or its subsidiaries in the USA and other countries. All rights are reserved. Terex® is a registered trademark of Terex Corporation in the USA and many other countries.

Copyright 2012 Terex Corporation.

Terex Cranes, Global Marketing, Dinglerstraße 24, 66482 Zweibrücken, Germany
Tel. +49 (0) 6332 830, Email: info.cranes@terex.com, www.terexcranes.com



www.terexcranes.com

Brochure Reference: TC-DS-I-E-BT 28106-07/12



WORKS FOR YOU.™